



DIGITAL SIGHT SERIES

Digital Cameras for
Microscopes

Nikon Digital Sight series

Choose the ideal microscope camera to suit every application, including the Digital Sight 10, which makes possible to switch between color and monochrome image capture at very high definition of 23.9 mega-pixels or 6K resolution, Digital Sight 1000, which directly displays microscope images on a full HD display without a PC, and the Digital Sight 50M, a monochrome high-sensitivity model suited to fluorescence photography.

Four camera options covering two computing platforms

Microscope Camera Digital Sight 1000	Microscope Camera DS-Fi3	Microscope Camera Digital Sight 10	Monochrome Microscope Camera Digital Sight 50M
			
→ P.3	→ P.4	→ P.6	→ P.7
2.0 megapixel Color Full HD	5.9 megapixel Color High-resolution	23.9 megapixel Color/Mono-chrome High-resolution	60.0 megapixel Mono-chrome Cooled
Frame rate 30 fps (1920x1080)	Frame rate 15 fps (2880x2048), 30 fps (1440x1024)	Frame rate 9 fps (6000x3984), 66 fps (1920x1080)	Frame rate 6 fps (9552x6336), 225.9 fps (640x480)
Max recordable pixels 1920x1080	Max recordable pixels 2880x2048	Max recordable pixels 6000x3984	Max recordable pixels 9552x6336
C-Mount	C-Mount	F-Mount	F-Mount

Using a tablet PC

Imaging software
NIS-Elements L
Advanced Solutions for your Imaging World



→ P.10

Using a desktop PC

Imaging software
NIS-Elements F D Br Ar
Advanced Solutions for your Imaging World



→ P.8

Only NIS-Elements L and F are compatible with Digital Sight 1000

Microscope Camera

Digital Sight 1000

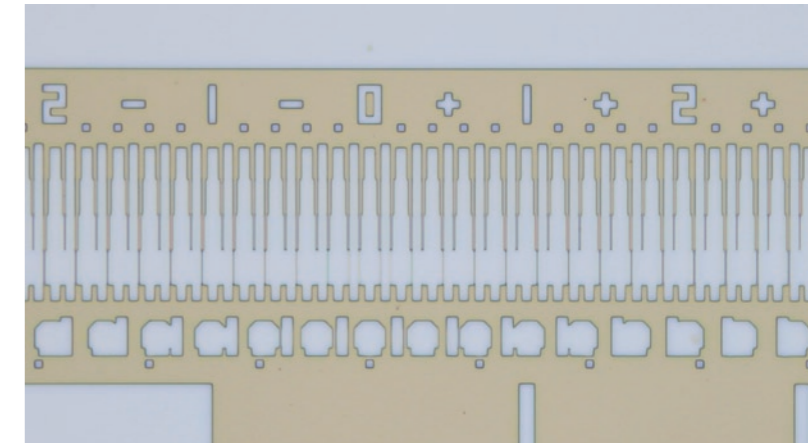
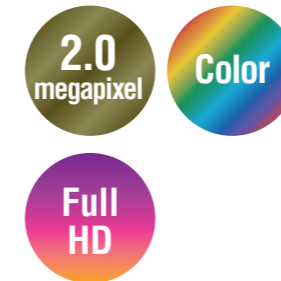

Semiconductor (IC wafer)
(Objective: TU Plan Fluor 20x on Nikon Eclipse microscope)

Low cost, Full HD Camera

Equipped with a 2 megapixel CMOS image sensor, it can display, capture, and save full HD microscope images of 1920 x 1080 pixels at 30 frames / second.

Easy operation on HDMI display

By connecting the microscope to a camera and HDMI monitor, movie and still images can be created, captured and data can be saved to an SD card. No PC connection is required to display scales and reticles, as well as to conduct simple measurements.

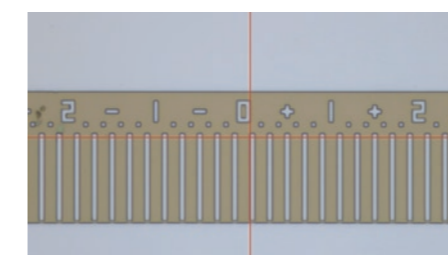
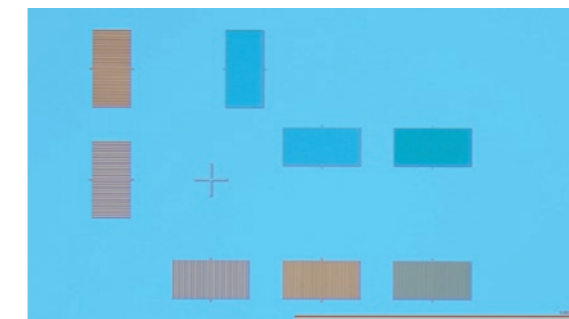

Cross Line (Line Display)

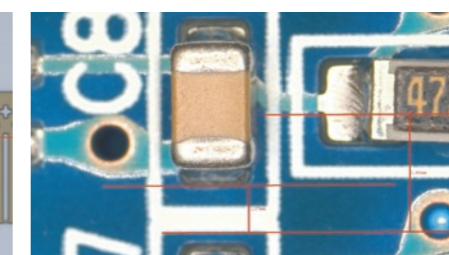

Perpendicular Distance Measurement

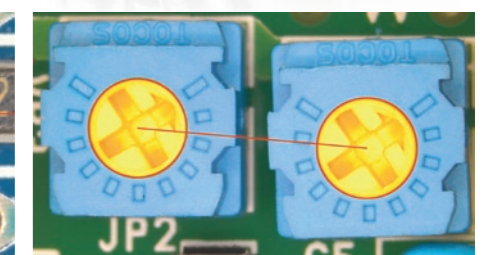

Circle Distance Measurement

Main Features

- Image Comparison
- Circle Distance Measurement
- Parallel Line Measurement
- Polygon Display
- Measurement Calibration
- Scale Bar Display
- Reticle Display
- Angle Measurement
- Concentric Circles Measurement
- Freehand Line Display
- Rectangle Display
- Coordinate Display
- Scale Reticle Display
- Saving Measurement Result
- Perpendicular Distance Measurement
- Circle Display
- Line Display

Microscope Camera DS-Fi3

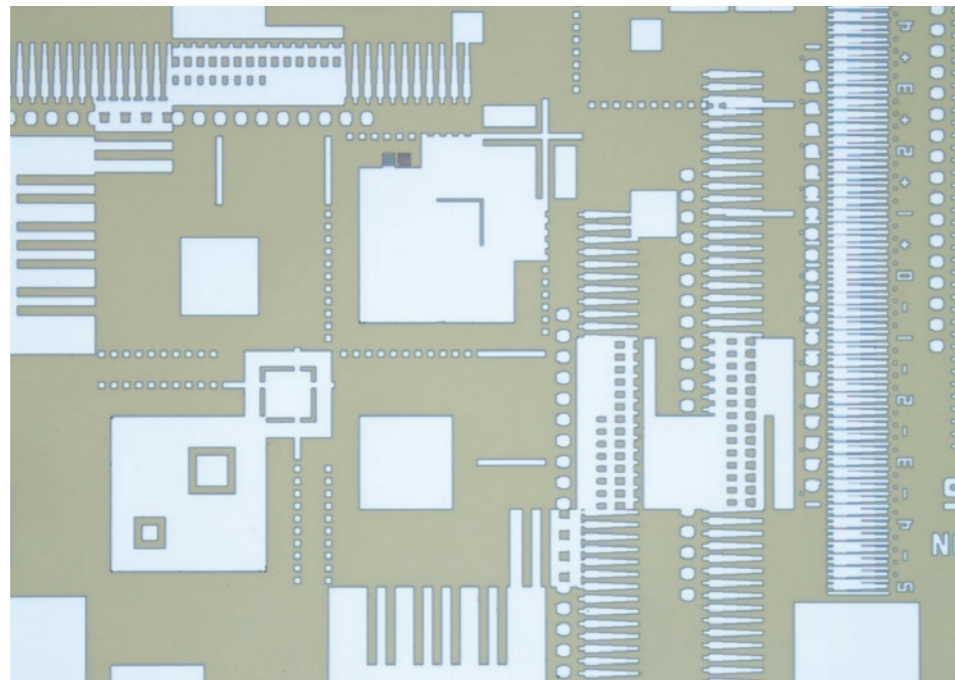

Semiconductor (IC wafer)
(Objective: TU Plan Fluor BD 20x on Nikon Eclipse microscope)

High-resolution images

A CMOS high density 5.9 megapixel sensor produces high resolution images. The USB3.0 data transfer allows fast focusing with high resolution, and easy image capture in all types of observation contrast methods such as brightfield, darkfield, differential interference contrast, and phase contrast.

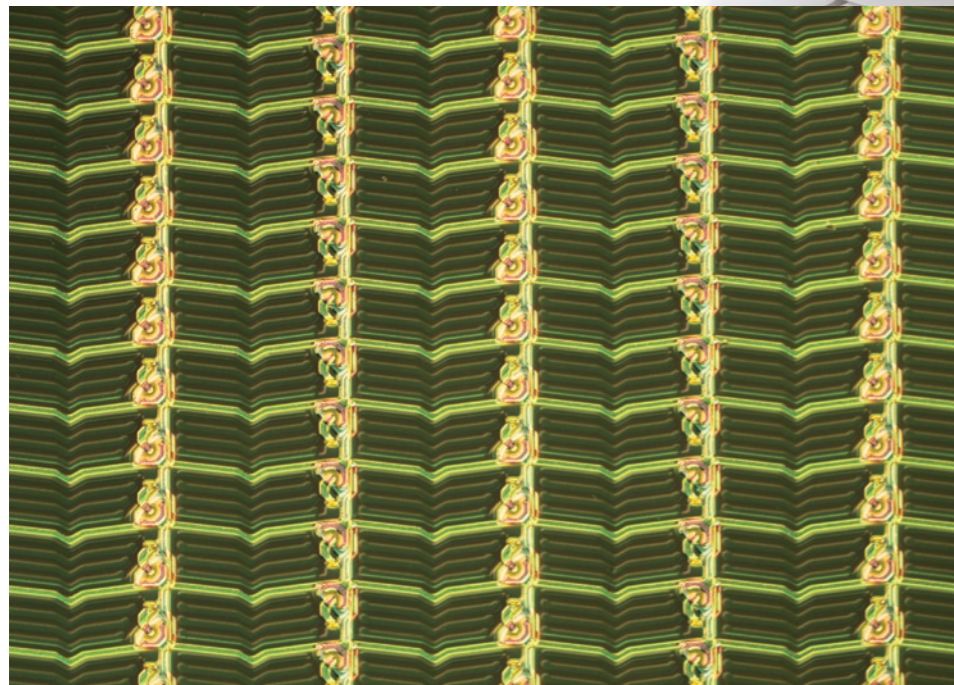

Liquid crystal panel
(Objective: TU Plan Fluor 10x on Nikon Eclipse microscope)

High-speed live display

Fast USB3.0 data transfer means fast, smooth live updating of images for finding samples or focusing, even at full resolution.

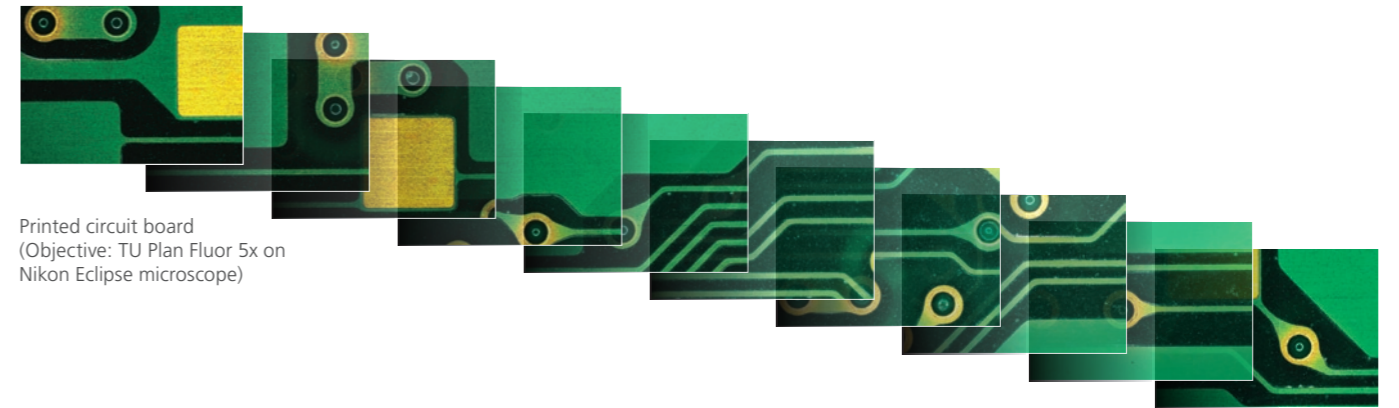

Printed circuit board
(Objective: TU Plan Fluor 5x on Nikon Eclipse microscope)

Superior color reproduction

Nikon is well-known for outstanding and lifelike color reproduction, and developing superior algorithms for creating results that look like the actual samples. These algorithms are used in all of the color cameras in the digital sight lineup.

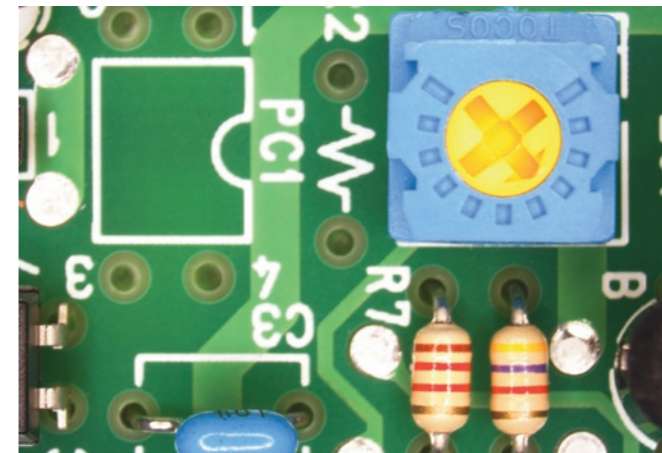

Printed circuit board
(Stereo microscope + LED ring lights)

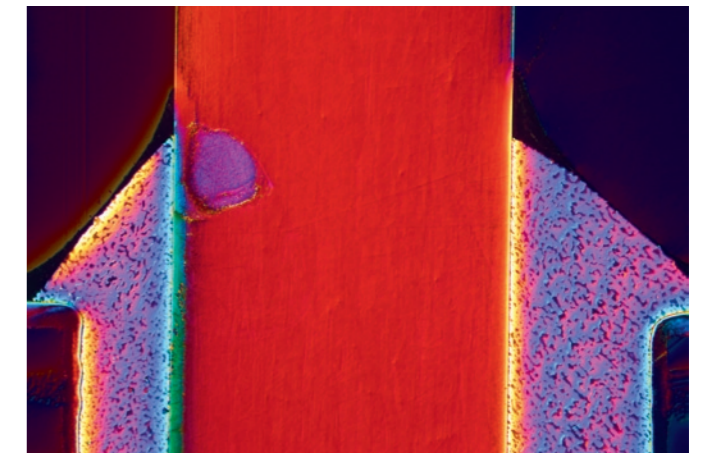

Printed circuit board (Connector)
(Objective: TU Plan Fluor BD 10x on Nikon Eclipse microscope)

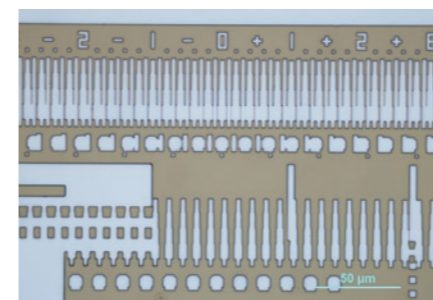

Semiconductor (IC wafer)
(Objective: TU Plan Fluor BD 50x on Nikon Eclipse microscope)

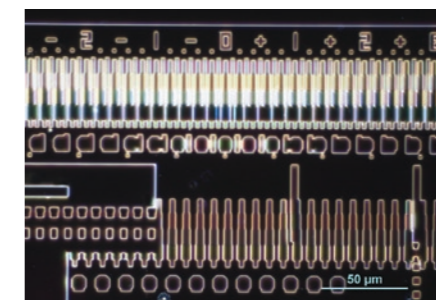

Semiconductor (IC wafer)
(Objective: TU Plan Fluor BD 50x on Nikon Eclipse microscope)

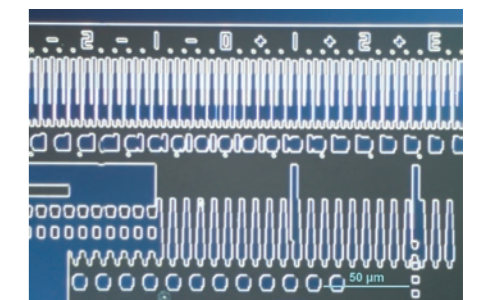

Semiconductor (IC wafer)
(Objective: TU Plan Fluor BD 50x on Nikon Eclipse microscope)

Camera Control

The DS-Fi3 interfaces with PC computers via a USB3.0 interface directly to the camera head, and uses NIS-Elements series software for image acquisition.

Covering a wide field of view at ultra-high definition 6K resolution. Achieves a one-shot, efficient image capture process.

Microscope Camera Digital Sight 10



High-definition observation

Digital Sight 10 enables unprecedented 6K ultra-high definition, capturing microscopic images at up to 6000 x 3984 pixels (23.9 megapixels).

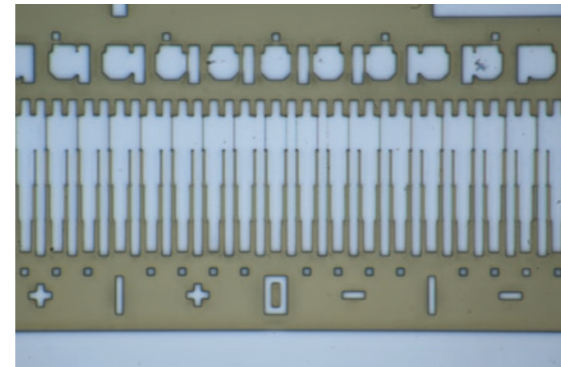

Wafer (IC pattern) (Objective: TU Plan Fluor 100x)



Before Digital Sight 10



Digital Sight 10



Resolution chart (Objective: TU Plan Fluor 10x)

Photography with the natural colors seen through the microscope

Nikon is a leader in development of algorithms for reproducing color just as the eyes see it

The Digital Sight 10 models' image processing engine is based on extensive data accumulated over many years of developing microscope color digital cameras, resulting in perfect reproduction of the colors your eyes see in the microscope.

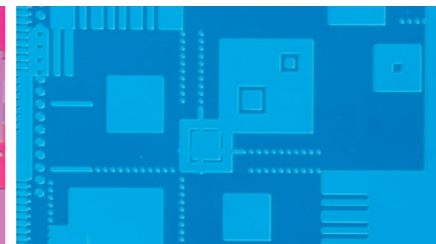
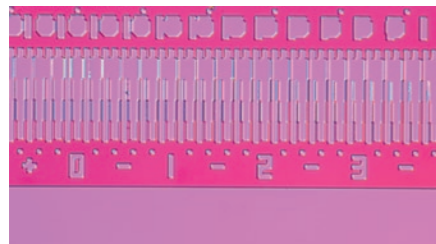

Left image: Semiconductor (IC wafer) (Objective: TU Plan Fluor BD 50x)

Right image: Semiconductors (IC wafer) (Objective: TU Plan Fluor BD 20x)



Example of combination with the LV150NA industrial microscope

High-speed display

Digital Sight 10 is able to output a standard or a user definable Region of Interest (ROI) directly from the sensor area.

(Position and size limits on ROI are present in the camera, but images are cropped using the SDK to provide an unrestricted ROI to the user.)

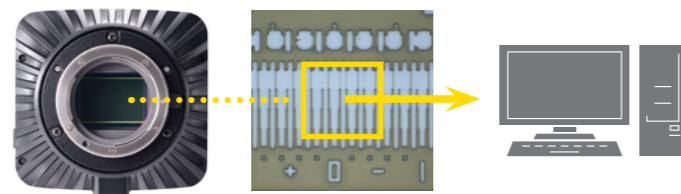

Achieves up to approximately **357 fps**

(3x3 binning, 128x128 ROI, exposure time: 100 μs)



*Digital Sight 10 adjusts image size in the vertical direction to enhance the frame rate above that of the DS-Ri2, Qi2, and Fi3 models.

Color and Monochrome shooting are both possible with one camera unit **During manual operation**

Color mode

Inserting the color filter optimizes the image from 400 to 680 nm in color live display and capture modes



Monochrome mode

Inserting the IR filter in place of the color filter now extends the IR imaging range from 400 to 850 nm in both live and capture modes.



Electric switching function

During electronic operation (using the 1x electronic adapter)

Easy motorized filter switching

Easy switching between color and monochrome modes using the imaging software is possible by a motorized, hands-free process.



1x electronic adapter

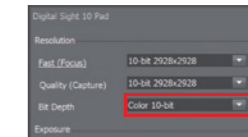

Switch with a single action in the imaging software

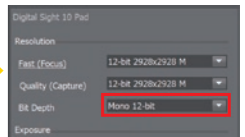

*A 1x electronic adapter and a separate PC equipped with specialized imaging software, NIS-Elements, are required for automated filter change operation.

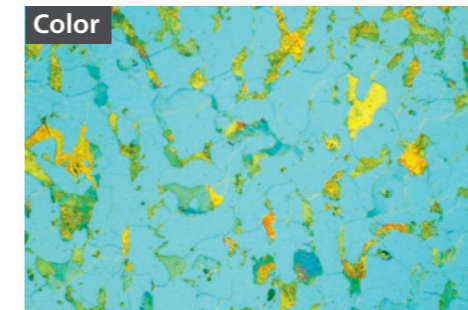

Metallic structure (aluminum) (Objective: TU Plan Fluor 50x)

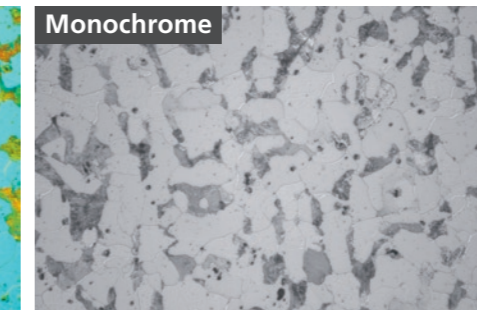

Example of combination with the MA200 inverted metallurgical microscope

Quickly and efficiently search wide fields of view, capture and analyze high-definition images

Monochrome Microscope Camera Digital Sight 50M



9K ultra-high resolution

The improved Digital Sight 50M boasts 3.8 times the number of pixels and 2.5 times the resolution of previous models. Even when using a low-magnification, high-NA objective lens, it fully demonstrates optical capabilities.

Low noise

Acquires dim fluorescent signals with ultra-low noise

Both 6e- read noise coupled with a large full-well capacity and 1.0e-/p/s dark current allow the acquisition of 14bit fluorescence images with very little noise.

High sensitivity

Detects even faint fluorescent signals

The Digital Sight 50M achieves quantum efficiency of 85%. Even faint fluorescence signals can be captured by the pixels on account of the broad 3.76 μm pixel pitch and high quantum efficiency.

Numerous image acquisition modes

Adjustable balance between quality and speed

There are three operation modes, making it possible to select the required speed and quality. Maximum frame rate of 225.9 fps for high-speed photography.

Integration with Nikon's Software Imaging Platform

Nikon's universal software platform, NIS-Elements combines powerful image acquisition, analysis, visualization and data sharing tools. With fully customizable user interfaces and seamless integration of Nikon microscopes, cameras and a wide variety of peripheral devices, NIS-Elements can serve as a simple interface for photo-documentation or power complex, conditional workflows with automated imaging and analysis routines. The NIS-Elements platform features various packages and software modules to meet the needs of even the most challenging applications.

HDR (High Dynamic Range) image acquisition

Ar Option Br D

HDR creates an image with appropriate brightness in both the dark and bright regions in a sample by combining multiple images acquired with different exposure settings. It is also possible to create HDR image using multiple captured images.

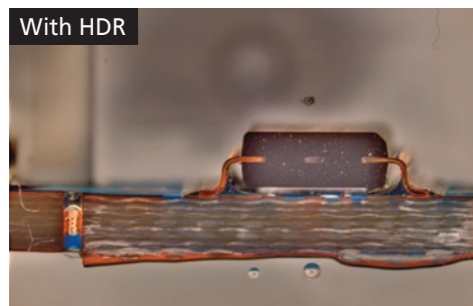

EDF (Extended Depth of Focus)

Option Ar Br D

Creates a single, all-in-focus image from images of differing focus. Such images can now be created by simply turning the focus knob.

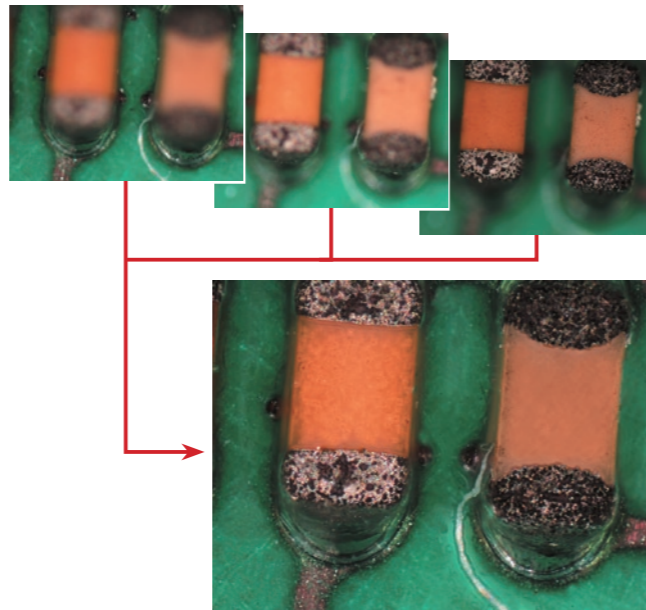

Selects the in-focus area and produces one all-in-focus image

Auto measurement (Object Counting)

Ar Br Option D

Performs binarization on images using previously set thresholds to measure the number, area, brightness, etc. of identified objects.

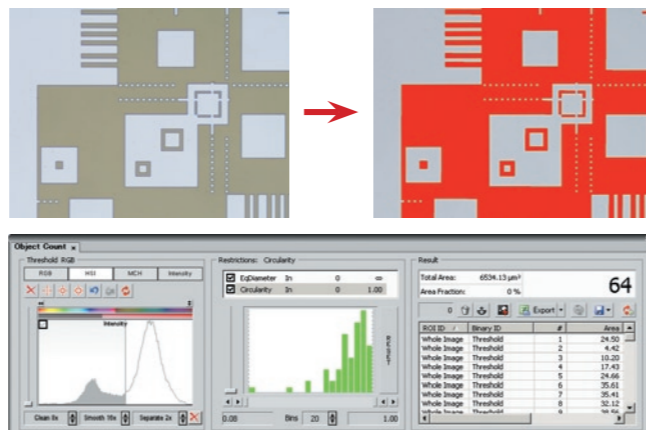

Manual measurement and image annotation

Ar Br D

Manual Measurement allows easy measurement of length and area by drawing lines or an object directly on the image. The results can be attached to the image, and also exported as text or to an Excel spreadsheet.

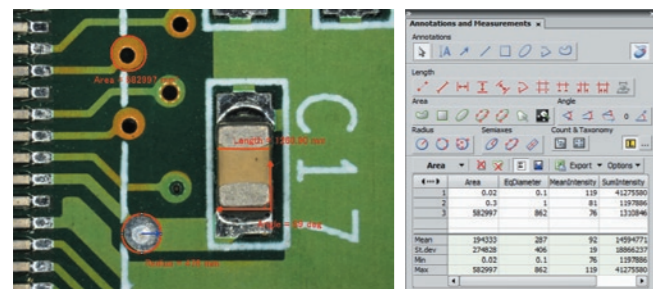

Grain size analysis

Option Ar Br D

Detects and measures grains in one and two phase samples according to JIS G0551, ASTM E112-13/E1382-97, ISO643 and GB/T 6394 standards.

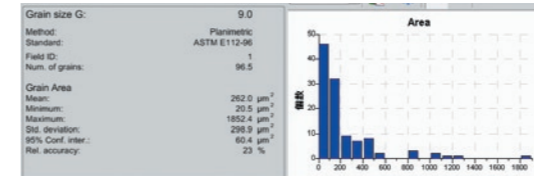
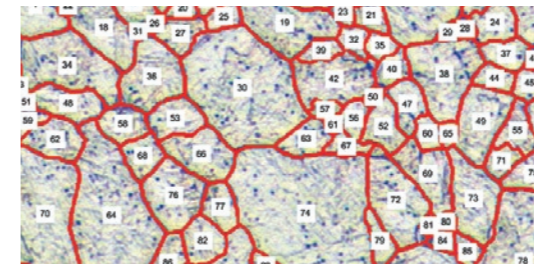

Cast iron analysis

Option Ar Br D

Detects, measures and classifies graphite content as well as ferrite content in graphite-corrected samples according to JIS G5502, ASTM A247-06 and ISO945-1 standards.

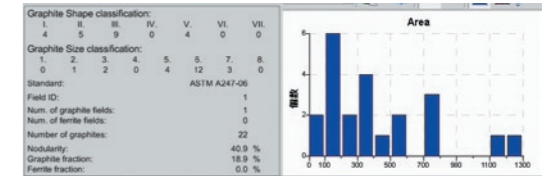
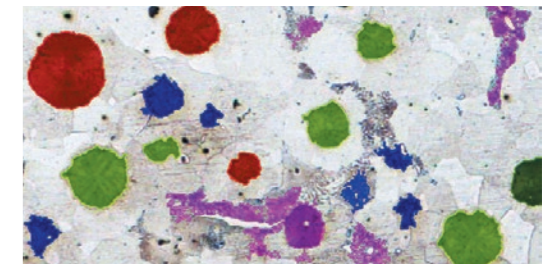
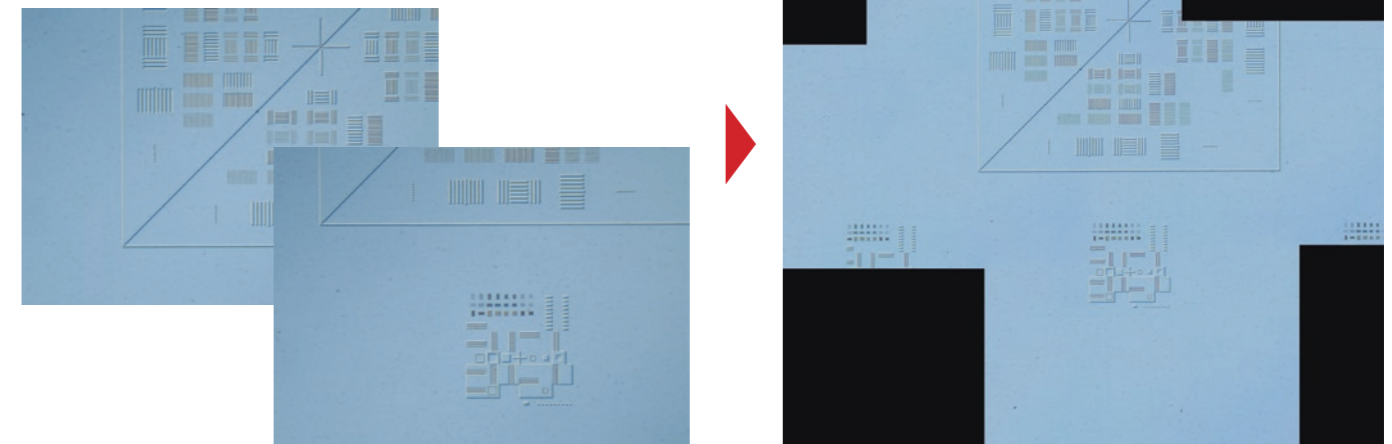

Image stitching (Large Image)

Option Ar Br D

Stitches together images acquired from multiple fields of view. This can occur from images as they are acquired or from previously captured images.



Measuring Software

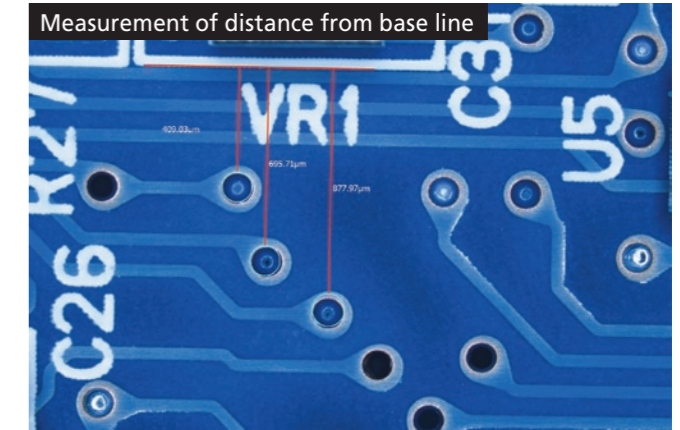
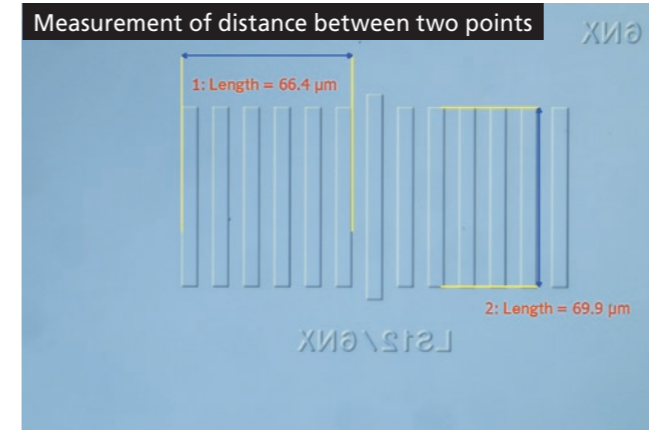

Intuitive control of microscope cameras from tablet PCs

Easily view images and control image acquisition settings for the Digital Sight 1000/DS-Fi3/Digital Sight 10 camera on a tablet PC using NIS-Elements L.

(Compatible OS: Windows® 10 Pro) * Nikon provides confirmed compatible tablet PCs with up-to-date specifications. Contact Nikon for details.

User Interface for naturally simple operation

NIS-Elements L displays various menus for image capture, saving, display, measurement and annotations using intuitive icons. It also supports touch screen operation.

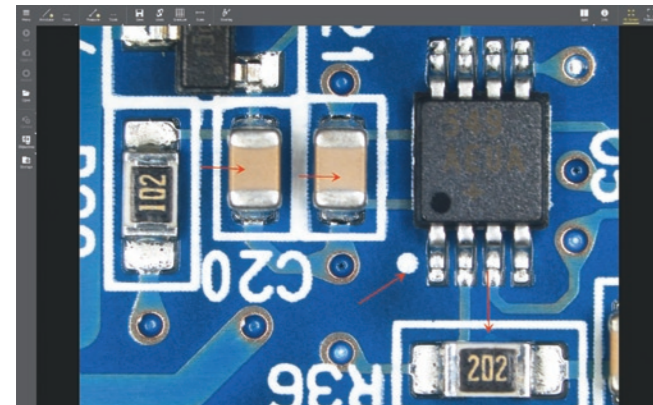

A wide variety of tools

NIS-Elements L enables the conducting of simple measurements on images, with input of lines and comments. These can also be written onto and saved with the image, and measurement data can be output.

Measurement function

- Line distance
- Area
- Circle
- Circle distance
- Pitch distance
- Angle

Annotate function

- Line
- Arrow
- Text
- Marker
- Polyline

Graticule/scale function

Crosshairs	Grid
Simple crosshairs	Horizontal scale
Circle	Vertical scale

Scene mode

Ten camera setting patterns for optimal color reproduction and contrast for each microscope light source, observation method and type of sample, as well as custom settings, can be selected.

Industrial Scene Mode

- Wafer/IC
- Metal
- Circuit board
- Flat Panel Display

Other functions

• **Split screen display:** A live image is displayed on the left side of the screen and the saved image is displayed on the right side. When synchronization is activated, synchronized magnification is applied to the both images.

• **Camera information:** A histogram and metadata of the image are displayed.

• **Full screen:** The image is displayed across the entire screen.

• **Saving:** The displayed image is saved with a new file name.

• **Live stream:** Easy live streaming to other PCs and mobile devices on the same network or via an Internet streaming services.

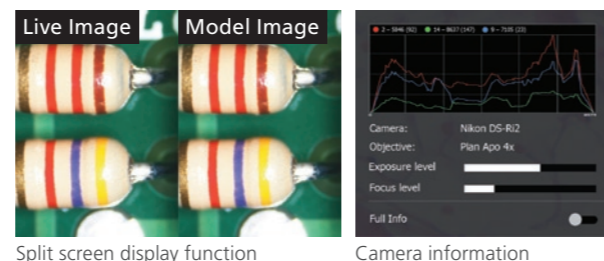

Dimensions

Digital Sight 1000

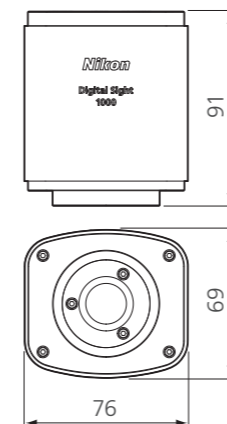

Weight: approx. 450 g

DS-Fi3

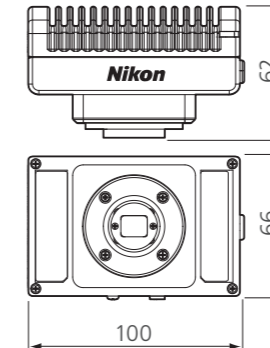

Weight: approx. 400 g

Digital Sight 10

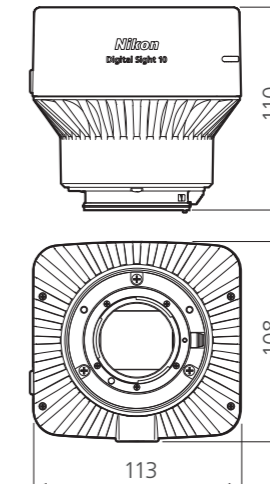

Weight: approx. 1,100 g



Digital Sight 10
Maintenance movie

Digital Sight 50M

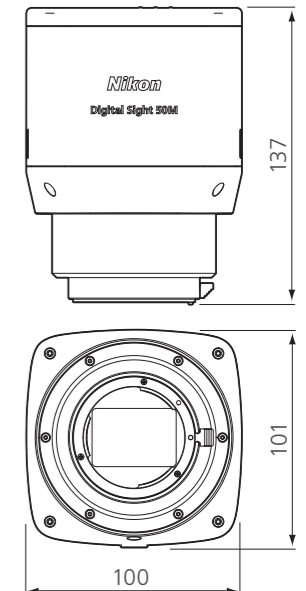

Weight: approx. 1,300 g

System Diagram

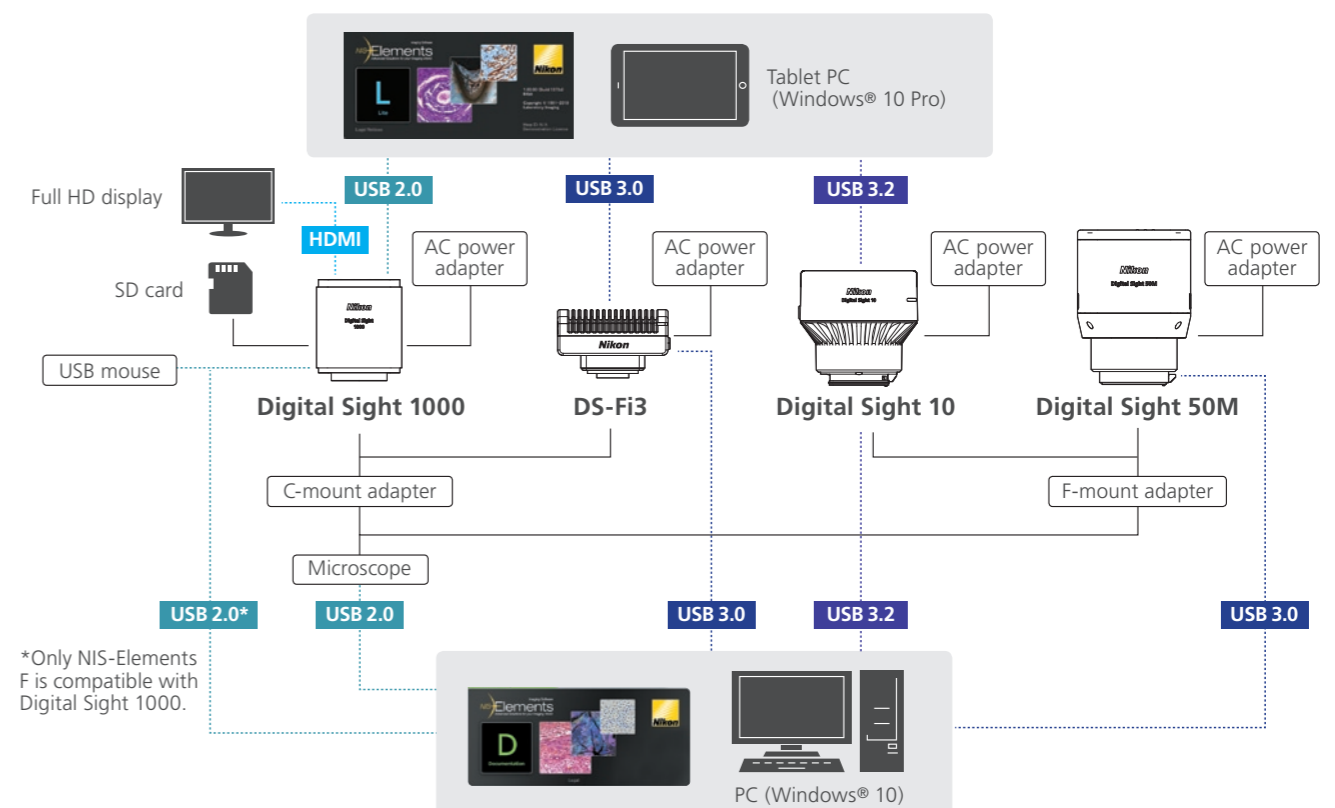

*Only NIS-Elements F is compatible with Digital Sight 1000.

Specifications

Model name	Digital Sight 1000	DS-Fi3	Digital Sight 10	Digital Sight 50M
Image sensor	1/2.8 inch Color CMOS image sensor Size: 5.57 × 3.13 mm	1/1.8 inch Color CMOS image sensor Size: 6.91 × 4.92 mm	Nikon FX-format Color/ Monochrome CMOS image sensor Size: 35.8 × 23.8 mm	Nikon FX-format Monochrome CMOS image sensor Size: 35.8 × 23.8 mm
Recordable pixels	1920 × 1080 pixels	All pixels: 2880 × 2048 2 Vertical and 2 horizontal pixels average: 1440 × 1024	6000 × 3984 pixels	All pixels: 9552 × 6336
Lens mount	C-mount		F-mount	
Cooling method	—			Electronic cooling
ISO sensitivity (recommended exposure index)	Standard: equivalent to ISO 150	Standard: equivalent to ISO 50 (Selectable from ISO 50 to ISO 3200 equivalent)	Equivalent to ISO 200 (color mode) Equivalent to ISO 800 (monochrome mode) (Selectable from ISO 125 to 8000 :in color / ISO 500 to 32000 in mono)	Equivalent to ISO 200
Quantum efficiency	—			85 %
Full well Capacity	—			45000e- (typ.)
Readout noise	—			6e-
Dark current	—			1.0e-/p/s (Ta=25°C)(typ.)
Live display mode* (maximum fps)	1920 × 1080 pixels: 30 fps	All pixels (2880 × 2048): 15 fps 2 Vertical and 2 horizontal pixels average (1440 × 1024): 30 fps	All pixels (6000 × 3984): 9 fps FullHD 3x3 pixels average (1920x1080): 66 fps	All pixels (9552 × 6336): 6 fps@8 bit, 1.9 fps@16 bit 3 × 3 pixels average @ 8 bit (ROI 640 × 480): 225.9 fps***
Exposure time	1 m sec–10 sec	100 μsec–30 sec	100 μsec–120 sec	150 μsec–120 sec
Photometry mode	Average photometry 1920 × 1080 pixels (all area)	Average photometry: Average intensity within the photometry area Peak photometry: Maximum intensity within the photometry area		
Exposure control	Automatic exposure, Manual exposure	One-time automatic exposure: Exposure time is adjusted automatically for one-time within the optimum range for the camera Continuous automatic exposure: Automatic exposure adjustment is performed continuously to keep the exposure within the camera Manual exposure: Exposure time and gain settings are made manually		
Exposure correction	Available	Average metering: ±1EV Step:1/6EV (some restrictions according to tone) Peak hold metering: -1 EV ~ ±0 EV		Average metering: -1 EV ~ +1/2 EV Peak hold metering: -1 EV ~ ±0 EV
Interface	USB2.0 (connect with PC or USB mouse) × 1, HDMI × 1, SD card slot x1**	USB3.0 (connect with PC) × 1, External trigger × 1	USB3.2GEN1,2 (connect with PC) × 1, External trigger × 1	USB3.2GEN1 (connect with PC) × 1, External trigger × 1
Power supply	AC100-240V 50Hz/60Hz			
Power consumption	3 W	4.8 W	18 W	27 W
Operating environment	0-40°C, 60% RH max. (without condensation)			

*Maximum frame rate depends on exposure time. **Both SD and SDHC memory cards are compatible with the Digital Sight 1000 camera.

***When using NIS-Elements, 16-bit mode can be selected for 1x1 and 2x2 digital binning, and 12-bit mode can be selected for 2x2, 3x3, 4x4 and 6x6. 8bit mode can be selected in all image size modes.

Specifications and equipment are subject to change without any notice or obligation on the part of the manufacturer. January 2023 ©2004-2023 NIKON CORPORATION

Microsoft and Windows are registered trademarks of Microsoft Corporation in the United States and other countries. Company and product names listed in this brochure are trademarks or registered trademarks of each company.

N.B. Export of the products* in this brochure is controlled under the Japanese Foreign Exchange and Foreign Trade Law. Appropriate export procedures shall be required in case of export from Japan.

*Products: Hardware and its technical information (including software)

WARNING TO ENSURE CORRECT USAGE, READ THE CORRESPONDING MANUALS CAREFULLY BEFORE USING THE EQUIPMENT.



NIKON CORPORATION

Shinagawa Intercity Tower C, 2-15-3, Konan, Minato-ku, Tokyo 108-6290, Japan
phone: +81-3-6433-3701 fax: +81-3-6433-3784
<https://industry.nikon.com/>

ISO 14001 Certified
for NIKON CORPORATION

ISO 9001 Certified
for NIKON CORPORATION
Industrial Metrology Business Unit

NIKON METROLOGY EUROPE NV

Interleuvenlaan 86 B-3001 Leuven, Belgium
phone: +32-16-74-01-00 fax: +32-16-74-01-03
E-mail: Sales.Europe.NM@nikon.com
<https://industry.nikon.com/en-gb/>

NIKON METROLOGY UK LTD.

UNITED KINGDOM phone: +44-1332-811-349 fax: +44-1332-639-881
E-mail: Sales.UK.NM@nikon.com

NIKON METROLOGY SARL

FRANCE phone: +33-1-60-86-09-76 fax: +33-1-60-86-57-35
E-mail: Sales.France.NM@nikon.com

NIKON METROLOGY GMBH

GERMANY phone: +49-211-45-44-69-51
E-mail: Sales.Germany.NM@nikon.com

NIKON INSTRUMENTS S.p.A.

ITALY phone: +39-055-300-96-01 fax: +39-055-30-09-93

NIKON METROLOGY, INC.

12701 Grand River Road, Brighton, MI 48116 U.S.A.
phone: +1-810-220-4360 fax: +1-810-220-4300
E-mail: Sales.NM-US@nikon.com
<https://industry.nikon.com/en-us/>

NIKON METROLOGY - MEXICO

MEXICO phone: +52-442-688-5067
E-mail: Sales.NM-MX@nikon.com

NIKON PRECISION (SHANGHAI) CO., LTD.

CHINA (Shanghai branch) phone: +86-21-6841-2050 fax: +86-21-6841-2060
(Beijing branch) phone: +86-10-5831-2028 fax: +86-10-5831-2026
(Guangzhou branch) phone: +86-20-3882-0551 fax: +86-20-3882-0580

NIKON INSTRUMENTS KOREA CO., LTD.

KOREA phone: +82-2-6288-1900 fax: +82-2-555-4415

NIKON SINGAPORE PTE. LTD.

SINGAPORE phone: +65-6559-3651 fax: +65-6559-3668
E-mail: NSG.Industrial-sales@nikon.com

PT. NIKON INDONESIA

INDONESIA phone: +62-267-864-3949 fax: +62-267-864-3950

E-mail: PTN.Instruments@nikon.com

NIKON SALES (THAILAND) CO., LTD.

THAILAND phone: +66-2633-5100 fax: +66-2633-5191