



The Eyes of Science

... *i* imagine perfection in digital microscopy



ECLIPSE
80*i*



Imagine a high-performance digital-imaging microscope system that can visualize weakly fluorescing molecules with the highest contrast and brightness you have experienced. Well, imagine no longer. Such a system has arrived.

The Eclipse 80i is the culmination of Nikon's breakthroughs in optical technologies and precision engineering. After listening carefully to our customers, we have incorporated an array of optimal digital-imaging optics that ensure uniform brightness over the whole view field and offer superb resolution to the peripheries, taking digital imaging to new heights.

In configuration with the DS-5M-L1 digital camera and a newly developed digital-imaging head, microscopy data of the captured image are automatically detected and can be saved together with the image file.

Epi-fluorescence microscopy featuring unparalleled S/N ratios and DIC imaging with an exceptional balance between resolution and contrast has become a reality.

An operating platform that is ergonomic and easy to manipulate has been incorporated into the Eclipse i-series, including a stay-in-position stage handle and tilting/telescoping ergonomic eyepiece tube whose length and inclination can be adjusted to suit each operator. A model with a rotatable stage that is especially useful for pathology documentation procedures and research-level DIC observations is also available.

The feature-packed 80i is the perfect platform for digital imaging in any laboratory or research situation.

ECLIPSE 80i

... breaking new ground in microscopy for the digital age.

— Built-in "fly-eye" optics ensure ultra uniform illumination— perfect for digital imaging. (See page 6)

— New ultra-high definition objectives, the Plan Apo VC series, deliver crisp high-resolution images right to the edge of the field of view. (See page 6)

— "Hi S/N Fluorescence System" incorporates a unique "Noise Terminator" that delivers an S/N ratio five times that of our previous fluorescence system. (See page 4)

— Digital-imaging head includes integrated reflected light illumination, binocular tube, dual imaging ports with an optical zoom lens optimized for digital imaging of Hi S/N fluorescence images. (See page 6)

— Imaging data, such as the magnification and fluorescence filter in use, are automatically detected and can be saved together with the image file when the image is captured with the DS-5M-L1 digital camera, which attaches to the digital-imaging head. (See page 6)

— High-contrast DIC images with superb resolution are possible, even at low magnifications. (See page 4)

— Solid construction ensures high-precision, stable focusing. (See page 5)

— Ergonomic eyepiece tube and platform design ensure comfortable operation for all users. (See page 7)



Imagine the clearest, highest-contrast images possible . . .

Unparalleled S/N ratio and contrast during fluorescence imaging

Hi S/N Fluorescence System employs a Noise Terminator

The digital imaging head and the universal epi-fluorescence illuminator incorporate Nikon's unique Hi S/N Fluorescence System. The Noise Terminator directs stray light out of the objective light-collection path, delivering a signal-to-noise (S/N) ratio five times that of our previous fluorescence system, increasing the image contrast during fluorescence microscopy and further extending the detection-level limit.

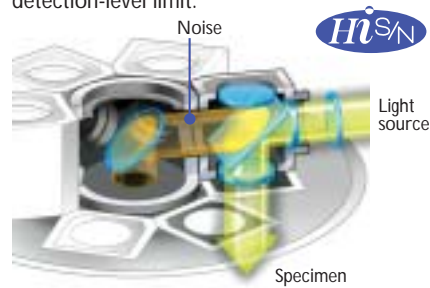

Stray light is thoroughly eliminated from the optical path in the filter turret.

"Excitation Balancer" continuously adjusts excitation wavelength

During observations or imaging of multi-stained specimens, the operator can easily emphasize the specific wavelength of the excitation light without changing the filter cubes. The spectral intensity of each excitation wavelength of the multi-band filter can be changed continuously by adjusting the sliding distance of the Excitation Balancer (option) into the optical path.



Adjustments can be made by simply sliding the excitation balancer back and forth.

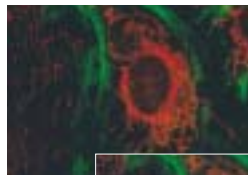

B excitation is emphasized.

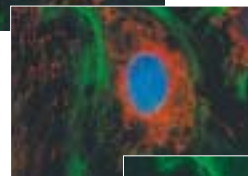

Standard excitation.



UV excitation is emphasized.



Six-filter turret

The filter turret can accommodate six, easily exchangeable filter cubes. The filters or mirror in the filter cubes can be easily replaced to create the desired combination. Phosphorescent filter labels are used on the turret cover, making it easy to see the names and positions of filter cubes in darkened rooms.



Filter cube labels glow in the dark for easy identification.

Upgraded DIC performance

Uniformly crisp images with high contrast and resolution

The composition of the material used in the DIC prism has been changed to make it possible to obtain high-contrast DIC images with excellent resolution and uniform coloration at any magnification.

- Two types of new DIC modules (dry) cover observations at 10X-100X magnifications.
- Three types of DIC prisms are available: standard, high-contrast and high-resolution.
- The shade (3D effect) of the image can be adjusted on the rotatable-stage model.

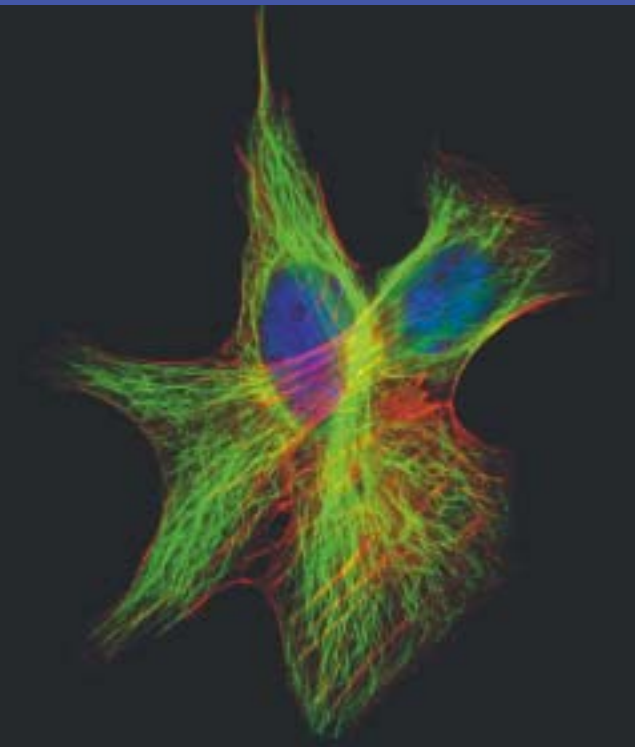

CFI 60 infinity optics

The objectives of Nikon's acclaimed CFI60 infinity optics have a 60mm parfocal distance, resulting in longer working distances and high N.A.'s, while producing crisp, clear images with high contrast and minimal flare. A flexible upgrade path is available to accommodate various intermediate modules.

Solid construction enables high-precision focusing

Utilizing computer-aided engineering (CAE), Nikon has significantly increased the stability of both the stage 'Z' movement and the arm section compared with previous Eclipse models. The increased stability minimizes the chance of the unwanted blur or image shifts that can occur during high-magnification observations.

Superhard stage surface

The superhard, smooth "Alumite" treatment applied to the stage surface ensures years of use.

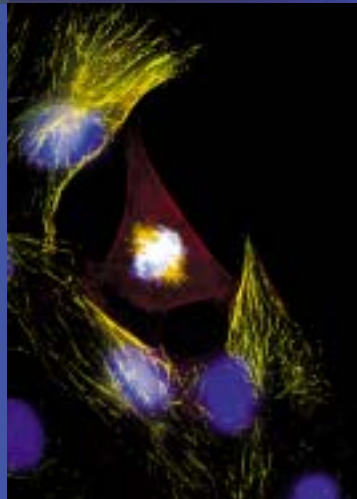

Imagine the perfect digital-imaging platform for all today's critical imaging needs . . .

Conception of "fly-eye" optics

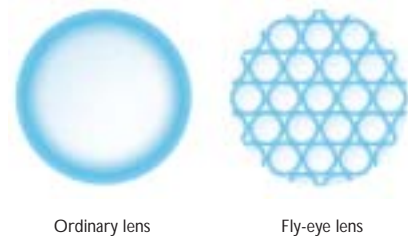

Ordinary lens

Fly-eye lens

Built-in "fly-eye" optics ensure uniform illumination

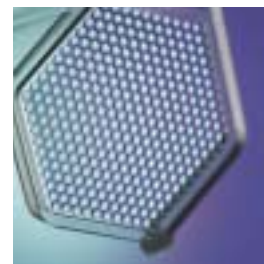

"Fly-eye" optics

A revolutionary "fly-eye" lens array has been incorporated into the transmitted-light illumination optics to achieve highly uniform illumination, making loss of light intensity at the peripheries of the view field a thing of the past. Uniform brightness is possible at all magnifications, while completely filling the objective back aperture.

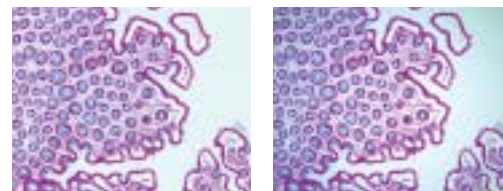

ECLIPSE 80i

Our conventional model



CFI Plan Apo VC 60x Oil, 60x WI, 100x Oil

Plan Apo VC objectives deliver high-resolution images, right to the edge

These objectives were specifically designed for digital-imaging applications that require optimal optical performance to images' periphery. They have exceptional resolution and image flatness throughout the view field, and shading has been eliminated by increasing light transmittance at the periphery. Images sharp to the edge of the view field are possible: Perfect for tiling images into specimen data. Chromatic aberration is corrected, even at the near UV range (405nm; h-line), making these objectives perfect for confocal microscopy.

Digital-imaging head creates an optimum digital-imaging platform

This all-in-one digital-imaging unit for taking high-contrast, crisp fluorescence images integrates Hi S/N epi-fluorescence illumination with the Noise Terminator, dual-port beam-splitting module with zoom optics and binocular-eyepiece tube. A "Motorized Excitation" shutter control is provided.

Automatic detection of microscopy status

When the Nikon DS-5M-L1 digital camera is mounted on the digital-imaging head, imaging data such as the objectives, imaging port, zoom magnification and fluorescence filter selection are automatically detected and can be saved as a text file in the image folder or output to an external imaging system. This eliminates the need to input data manually. Creating a large database of images taken at different settings is now easier than ever.

* Dedicated accessories and DS-5M-L1's software update are necessary. Save function is available soon.

Optical-zoom function

A 0.8X-2.0X optical-zoom mechanism at the rear port allows imaging at desired magnifications. Unlike digital zoom, optical zoom produces silky-smooth images, maximizing the total pixels of the CCD.

Dual port

Two output imaging ports allow a variety of imaging devices to be mounted simultaneously. The front port is perfect for confocal and quantitative measurement applications as minimum lenses are used.

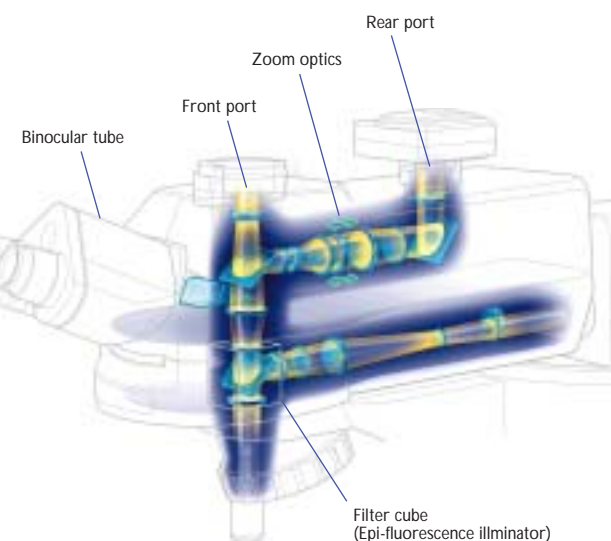

High-definition digital imaging is a snap — DS-5M-L1 digital camera

— Outstanding images with a definition of 5 million pixels can be captured without connecting to a PC.

— The 6.3-type LCD monitor in the camera control unit offers excellent resolution and enables focusing via the monitor.

— When mounted on the digital-imaging head, imaging data such as the magnification and filter selection are automatically detected and can be saved together with the captured image file.

* Dedicated accessories and DS-5M-L1's software update are necessary. Save function is available soon.

— The camera is network-ready without connection to a PC, enabling the sharing of images with other PCs via a network. Some camera functions can be controlled via the network.

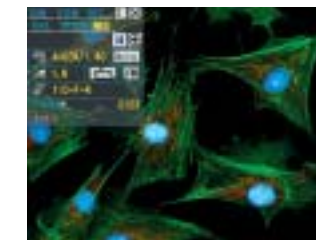

Status-check GUI on DS-5M-L1 monitor

Imagine the most ergonomically sound design ever . . .



Stay-in-position stage handle

The handle of the new mechanical stage stays at a fixed position near the focusing knob throughout the full range of X/Y stage movement, so the operator's hand can remain comfortably on the desk at the same position even when observation points are repeatedly changed. The height- and tension-adjustable stage handle can be set to suit each operator.

Centering rotatable stage model

The rotatable-stage model allows image documentation at the desired angle, improving composition. The contrast-shading angle of the DIC image is also adjustable.



Ergonomic tube

The new ergonomic binocular-eyepiece tube can be inclined at angles from 10° to 30° and the eyepieces can be extended up to 40mm. This ensures an optimum eye point and comfortable viewing posture, regardless of the operator's physique or if intermediate modules have been attached, greatly reducing neck and shoulder strain during long hours of observation.



Eye-level riser

The eye-level riser can raise the eye point height in 25mm increments (up to 100mm* maximum).

*The number of risers that can be used at any one time depends on the tube or intermediate modules being used.



DSC port for the ergonomic tube

A C-mount digital camera can be attached to the ergonomic tube using the optional DSC port with a 0.7X magnification. This is convenient for matching the frame of the image to be captured by the digital camera to the view field seen through the eyepieces.

Imagine the widest range of system expansion to meet all applications . . .

. . . from basic laboratory research to top-level, cutting-edge research



Configured with confocal system, digital camera and digital imaging head

For high-end bioscience research

Confocal microscopy and digital-imaging techniques complement each other with this configuration.

- New Plan Apo VC objectives provide razor-sharp high-contrast images in confocal microscopy.
- Status-check function, which automatically detects imaging data, can be used to create an image database.

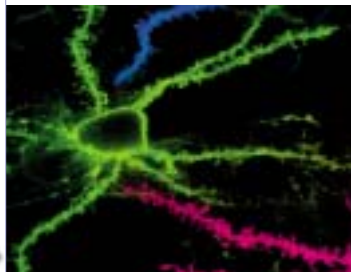

- Hi S/N Fluorescence System produces images with extraordinary brightness and a high S/N ratio.
- Clear and crisp DIC images are possible at any magnification.
- Optical-zoom function ensures high-definition images during magnification.
- The front port of the dual port is perfect for confocal and quantitative measurement applications.

For various experiments or general research

This configuration is suitable for all types of image documentation and research, from pathology and cell biology to material science investigations.

- Noise Terminator ensures digital fluorescence images with exceptional S/N ratios.

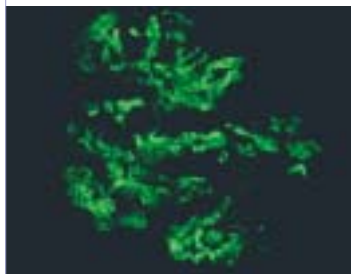

- Excitation Balancer allows specific wavelengths in multi-stained specimens to be emphasized.
- Universal epi-illuminator enables various episcopic observations for material science research.
- Optimal camera settings for each observation method can be selected from the menu of the DS-5M-L1 digital camera.

For pathology inspection or documentation

This configuration is ideal for pathology and related applications. High-definition digital images can be easily documented in a relaxed posture.



- “Fly-eye” optics ensure even illumination intensity.
- Ergonomic tilting tube reduces strain during long hours of observation.
- Specimen holder for one slide facilitates quick, one-handed changes of specimens.
- 5-megapixel images can be easily captured and shared among PCs using the DS-5M-L1 standalone digital camera.

“Hi S/N” epi-fluorescence microscopy



The new epi-fluorescence illuminators come standard with the Noise Terminator, which eliminates stray light leaking from the filter cube, producing high-contrast images with greater S/N ratios when observing weakly fluorescing specimens. The desired wavelength of a multi-stained specimen can also be emphasized with the unique Excitation Balancer. Up to six filter cubes can be mounted in the filter turret, while the mirror and all filters can be easily changed to suit individual applications.

Nomarski DIC microscopy

The new DIC method results in well-balanced images with outstanding contrast and resolution. Crisp and clear images with perfectly even color are obtainable, even at low magnifications. Three types of DIC prisms are available: standard, high-contrast and high-resolution. The shade direction of DIC images can also be adjusted on the rotatable-stage model.

Hi S/N epi-fluorescence/DIC microscopy

By using the high-performance DIC method in combination with Hi S/N epi-fluorescence illumination, researchers can accurately locate fluorescent-tagged structures or proteins and visualize the cellular morphology of a specimen. Used in conjunction with the new Plan Apo VC objectives, digital imaging with the highest resolution and aberration correction throughout the view field is possible.

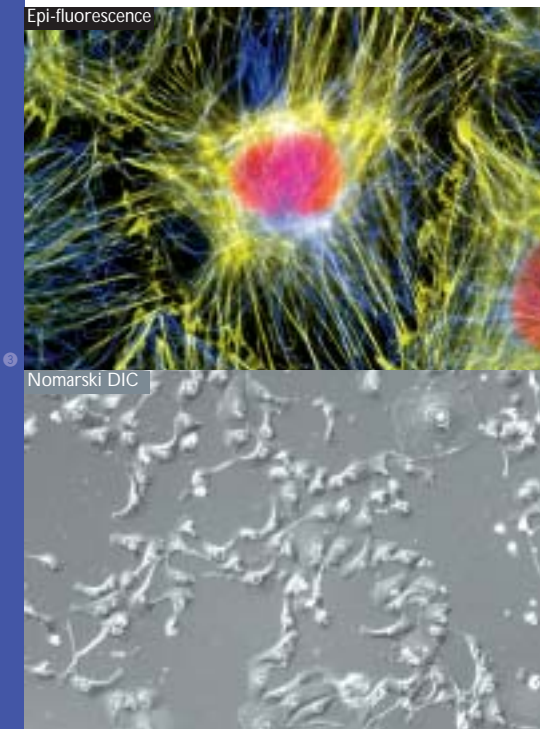

. . . applying various methodologies

Phase-contrast microscopy

Nikon has specially developed its unique Apodized Phase Contrast objectives for phase-contrast microscopy. These objectives enable researchers to detect minute structures—previously difficult to detect due to annoying halos—with excellent contrast and a much wider tonal range. This is ideal for specimens with varied refractive indices.

Brightfield microscopy

The new “fly-eye” lens array in the illumination optics provides uniform brightness to the edge of the view field. The CFI60 infinity optics are acclaimed for their excellent sharpness and superior color fidelity, while the Plan Apo VC objectives provide extraordinarily high resolution over the entire image. By using the 1X-100X condenser, users can view images at all magnification ranges, from ultralow to high, without having to change the condenser. The 1X objective is ideal for pathology work requiring a larger image field.

Darkfield microscopy

Our dedicated condensers for darkfield microscopy allow clear observation of blood or the minute structure of flagella. Dry- and oil-type condensers are available.

Simple polarizing microscopy

Polarizing microscopy is as simple as inserting a polarizer over the field lens and an analyzer in the arm slot. It is ideal for observing birefringent samples such as collagen, amyloids and crystals.

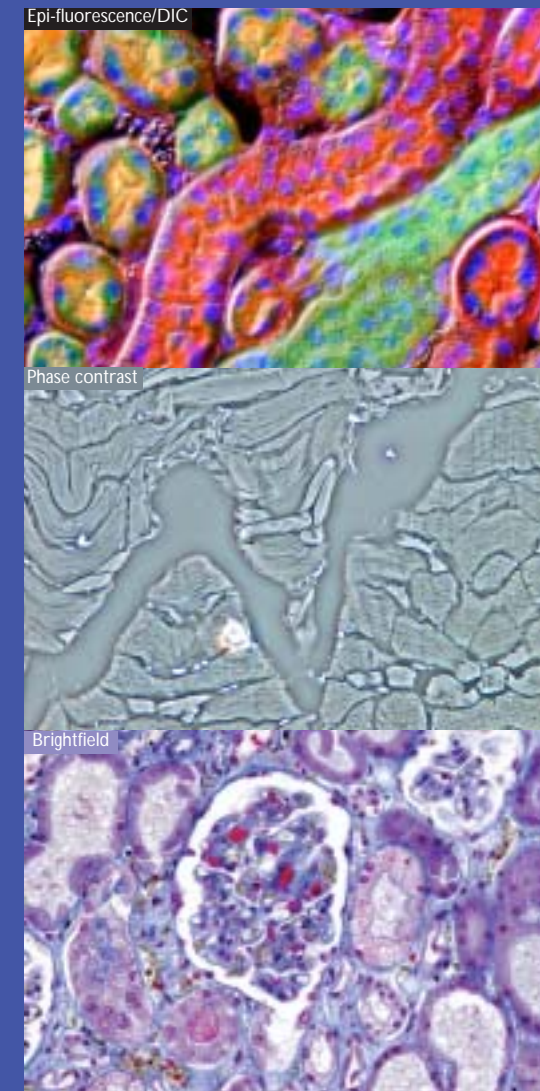

... a wide range of accessories too.



C1 confocal microscope system

The C1 is a compact, personal type of confocal laser microscope system that provides the highest quality images of its class. Resolution, contrast and fluorescent-image brightness are all state of the art. Image sizes of up to 2K by 2K at 12-bit image depth can be easily scanned.

- Filters are interchangeable to match fluorescent dyes, enabling researchers to use the latest probes or dyes available.
- 3-channel simultaneous detection is possible, including simultaneous 3-channel fluorescence, 3-channel plus DIC, time-lapse recording and spatial analysis.



DXM1200F ultrahigh-definition digital camera

The DXM1200F is a top-level digital camera with 12 million output pixels. It features a CCD more than twice as sensitive as conventional models, providing stunning fluorescence capabilities. Frame selection, auto categorizing, auto print and other features facilitate imaging of a large number of images.

- Sparkling digital images that are better than those taken with film-based cameras, thanks to Nikon's proprietary IPS (Inter Pixel Stepping) high-density imaging technology.
- Low-noise design that incorporates high-S/N digital-circuit technology and a new CCD with outstanding sensitivity.

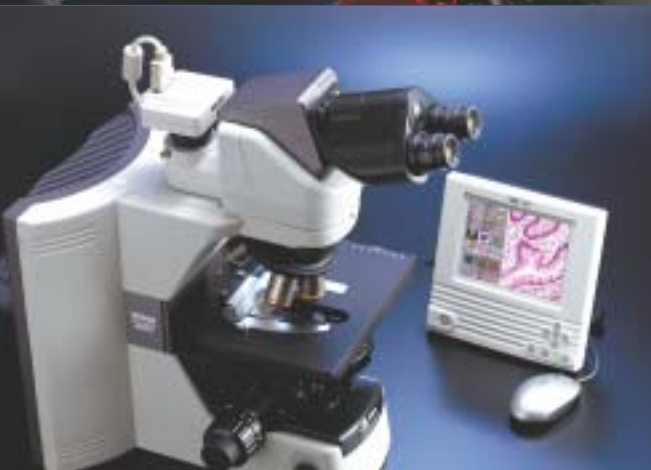

DS-5M-L1 "Digital Sight" all-in-one digital camera system

The standalone design of the DS-5M-L1 allows independent operation for high-definition digital imaging at a resolution of 5 megapixels (2560 x 1920 effective pixels) without connecting to a PC or external monitor.

- A large 6.3-inch high-definition LCD monitor built into the camera controller allows the operator to focus the image on the monitor without needing to use the eyepieces.
- Image-processing capabilities include shading correction, tone settings and simple measurements.
- An exclusive scene function that utilizes a preprogrammed mode provides optimum imaging for each observation method.

Digital-imaging head

The digital-imaging head can be integrated with the HI S/N epi-fluorescence illuminator, dual port with 0.8X–2.0X optical zoom lenses and a binocular eyepiece tube. Thanks to Nikon's unique Noise Terminator, digital imaging with a significantly improved S/N ratio is also possible. And when used with the DS-5M-L1 digital camera, imaging data such as the magnification and filter in use are automatically detected and can be stored together with the captured image file.



*: Accessories such as dedicated nosepiece and DS-5M-L1's software update are necessary.

Universal epi-fluorescence illuminator

The filter turret can accommodate up to six filter cubes. The built-in Noise Terminator dramatically improves the S/N ratio and image contrast. By sliding the Excitation Balancer through the optical path, it is possible to continuously adjust the intensity of each excitation wavelength of a multi-stained specimen. The epi-fluorescence illuminator can be used for various applications that require episcopic illumination, such as material science investigations.



Ergonomic tube

The tube can be inclined at angles from 10° to 30° and the eyepieces can be extended up to 40mm. With the optional DSC port, featuring a 0.7X magnification, a C-mount digital camera can be easily attached to the ergonomic tube.



Tube inclination is adjustable 10°–30°

Eyepiece can be extended up 40mm

Eye-level riser

The eye-level riser can raise the eye-point height in 25mm increments, up to a maximum of 100mm*, to suit individual requirements.



* The number of risers that can be used at any one time depends on the tube or intermediate modules being used.

Quadrocular adapter

Two CCTV cameras or one CCTV camera and a digital camera can be attached to the trinocular eyepiece tube while maintaining the same eye level.



Double port

Mounted between the main body and the eyepiece tube, the double port enables the simultaneous use of two CCTV camera systems or one CCTV camera and one digital camera.



Magnification module

The turret system allows the intermediate magnification to be changed to 1X, 1.25X, 1.5X or 2X, enabling the operator to frame the image to be captured with a digital camera so it matches the view field seen through the eyepieces.



Teaching heads

This option, which includes a built-in pointer, allows simultaneous viewing of a single specimen without compromising the brightness. Styles suitable for two people (side by side and face-to-face) to 10 people are available.



Drawing tube

The drawing tube allows both the image of a specimen and the drawing to be seen through the eyepieces. When needed, 100% of the light can be sent to the observation port.

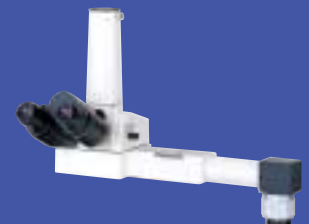

Double-lamphouse adapter

The double-lamphouse adapter allows two different light sources to be simultaneously attached to the microscope, eliminating the need to change the lamphouse and carry out time-consuming centering procedures.



FX-III series photomicrographic equipment

The FX-III series utilizes a direct-projection system with a swing-out prism for fast exposure setting and accurate metering.

U-III: 0.1% and 1% spot exposure, and 35% integrated-average measurement modes

H-III: 1% spot and 35% integrated-average measurement modes

P-III: Manual exposure model

System Diagram

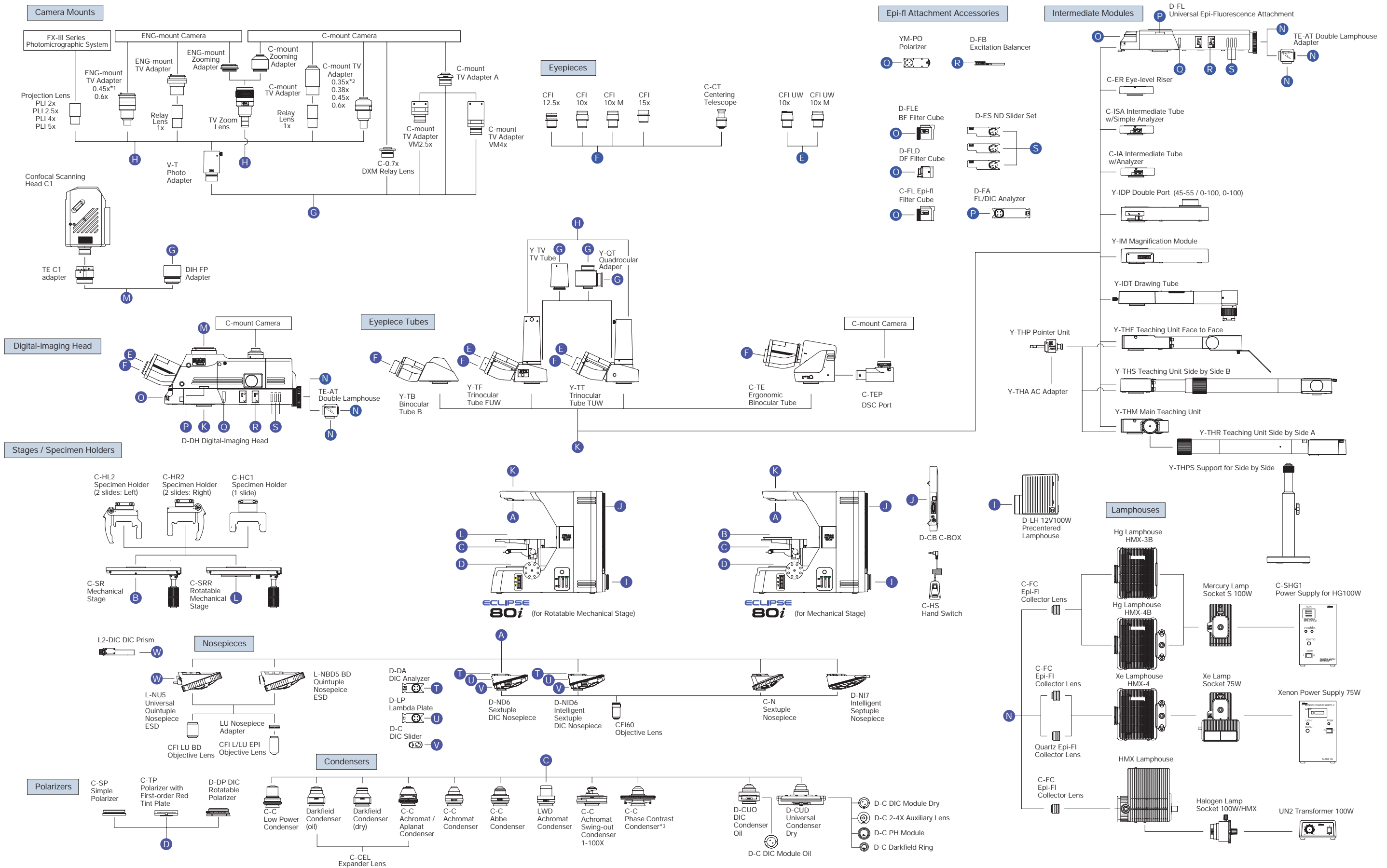

*1: Use the dedicated 0.45X adapter for the double port sub-port. The 0.6X adapter cannot be used with the double port sub-port.
 *2: Use the dedicated 0.35X adapter for the double port sub-port.

*3: Cannot be used with 80i model for rotatable mechanical stage.

Specifications

Magnification	10–1500X
Optical system	CFI60 Infinity Optical System
Coarse/fine focusing	Fine: 0.1mm per rotation Coarse: 14mm per rotation Minimum reading: 1 micron on left side knob Coarse motion torque adjustable Refocusing function (focus clamp)
Illumination	12V-100W halogen lamp 100-240V (worldwide voltage) Built-in "Fly-eye" optics for optimal digital-imaging illumination
Built-in filter	NCB11, ND8, ND32
Eyepiece tube	Digital Imaging Head Binocular tube B (for F.O.V. 22mm) Trinocular tube "F" UW (for F.O.V. 22mm/25mm, observation/photo: 100/0, 0/100) Trinocular tube "T" UW (for F.O.V. 22mm/25mm, observation/photo: 100/0, 20/80, 0/100) Ergonomic binocular tube (for F.O.V. 22mm, inclination:10-30°, extension: 40mm) DSC port: 50/50, 100/0 (optional)
Eyepiece lens	10X (F.O.V.: 22mm), 10X M photo mask (F.O.V.: 25mm), 12.5X (F.O.V.: 16mm), 15X (F.O.V.: 14.5mm), UW 10X (F.O.V.: 25mm), UW 10X M photo mask (F.O.V.: 25mm)
Nosepiece	Sextuple nosepiece, DIC sextuple nosepiece, Intelligent DIC sextuple nosepiece, Intelligent septuple nosepiece
Stage	Super-hard Alumite coated surface Stay-in-position stage handle Stage handle height and tension adjustable Rectangular 159mm x 243mm surface stage, 78mm x 54mm cross travel (x-y movement) 1-slide or 2-slide specimen holder available (option)
Stage rotation	Centerable, 220 degrees (80i Rotatable Stage model)
Condenser focusing stroke	37mm
Intermediate accessories	Universal epi-fluorescence Illuminator (6 filter positions, material application capability) Teaching heads, Double port, Magnification module, Drawing tube, Eye-level riser
Observation method	Brightfield, Epi-fluorescence, DIC, Phase contrast, Darkfield, Simple polarizing, Epi/brightfield, Epi/Darkfield, Epi/DIC, Epi/Simple polarizing

Digital-Imaging Head, Universal Epi-illuminator Specifications

	Digital Imaging Head	Universal Epi-illuminator
Application	Epi-fluorescence, Materials, Confocal, Quantative analysis	
	Dual camera	(Depends on eyepiece tube or double port)
Light distribution	3-way (Eye/Front/Rear) 100% to each port	(Depends on eyepiece tube)
Optical output ports	Front port: 1X, Diameter 52mm Rear port: Optical zoom 0.8X - 2.0X(continuous), Zoom ratio 2.5 :1, C-mount	(Depends on eyepiece tube or double port)
Inclination angle	25 degrees	(Depends on eyepiece tube)
F.O.V.	Max. 25mm	
Filter turret	6 positions	
HiS/N Noise Terminator fluorescence	Available	
Aperture diaphragm	Centerable, detachable; diameter 1-9mm	
Field diaphragm	Centerable, detachable; diameter 1-9mm	
ND filter	ND4, ND8, ND16	
Light shield shutter	Motorized (controlled by external switch)	Manual
Analyzer slot	Available	
Polarizer slot	Available	
Usable light sources	Mercury, Xenon, Halogen (centering)	
External connection	USB, C1 interlock, C-box connector	—
Status-check function	Available with digital camera DS-5M-L1 combination	—

Dimensional Diagrams

Unit: mm

Configured with digital imaging head

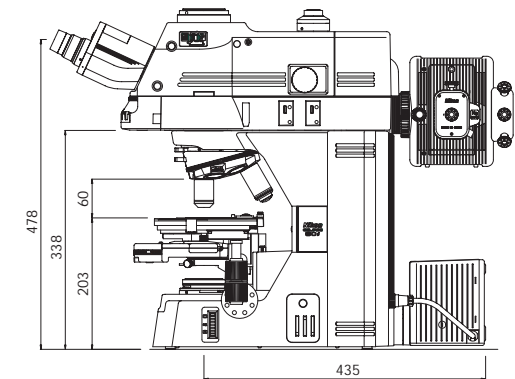
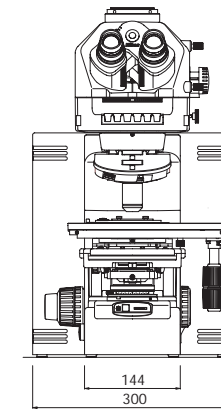

Configured with universal epi-fluorescence illuminator and ergo tube

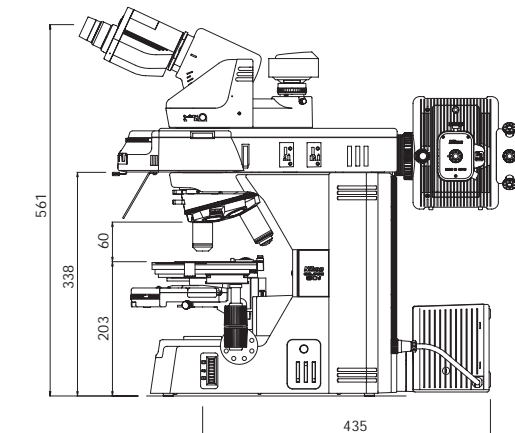
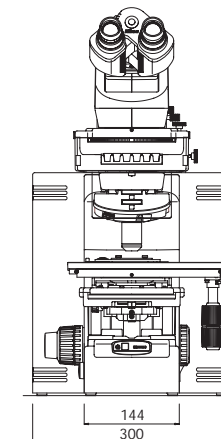

Configured with trinocular tube TUW

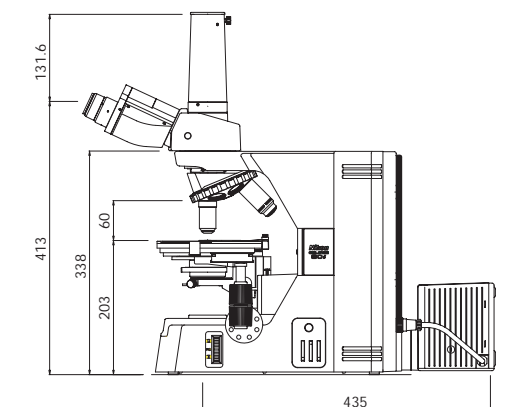
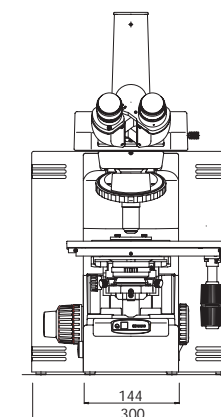

Microscopy images courtesy of:

- 1 Momoki Hirai, Professor, Department of Integrated Biosciences, Graduate School of Frontier Sciences, The University of Tokyo.
- 2 Naoyuki Miyokawa, M.D., Ph.D., Associate Professor, Dept. of Surgical Pathology, Asahikawa Medical College Hospital.
- 3 Dr. Torsten Wittmann, The Scripps Research Institute.

Nikon has reduced the amount of chromium, cadmium and lead used in the Eclipse-i Series to an absolute minimum to diminish its environmental impact.

Please contact Nikon for a handy pamphlet listing compatible accessories, including objectives and epi-fluorescence filters.

Specifications and equipment are subject to change without any notice or obligation on the part of the manufacturer. December 2003. ©2003 NIKON CORPORATION



WARNING

TO ENSURE CORRECT USAGE, READ THE CORRESPONDING MANUALS CAREFULLY BEFORE USING YOUR EQUIPMENT.



* Monitor images are simulated.

Company names and product names appearing in this brochure are their registered trademarks or trademarks.

NIKON INSTECH CO., LTD.

Parale Mitsui Bldg., 8, Higashida-cho, Kawasaki-ku, Kawasaki, Kanagawa 210-0005, Japan
phone: +81-44-223-2167 fax: +81-44-223-2182
www.nikon-instruments.jp/eng/
www.i-series.com

NIKON INSTRUMENTS (SHANGHAI) CO., LTD.

CHINA phone: +86-21-5058-5055 fax: +86-21-5058-5060

NIKON SINGAPORE PTE LTD

SINGAPORE phone: +65-6559-3618 fax: +65-6559-3668

NIKON MALAYSIA SDN. BHD.

MALAYSIA phone: +60-3-78763887 fax: +60-3-78763387

NIKON INSTRUMENTS EUROPE B.V.

P.O. Box 222, 1170 AE Badhoevedorp, The Netherlands
phone: +31-20-44-96-222 fax: +31-20-44-96-298
www.nikon-instruments.com/

NIKON FRANCE S.A.

FRANCE phone: +33-1-45-16-45-16 fax: +33-1-45-16-00-33

NIKON GMBH

GERMANY phone: +49-211-9414-0 fax: +49-211-9414-322

NIKON INSTRUMENTS S.p.A.

ITALY phone: +39-55-3009601 fax: +39-55-300993

NIKON AG

SWITZERLAND phone: +41-43-277-2860 fax: +41-43-277-2861

NIKON UK LTD.

UNITED KINGDOM phone: +44-20-8541-4440 fax: +44-20-8541-4584

NIKON INSTRUMENTS INC.

1300 Walt Whitman Road, Melville, N.Y. 11747-3064, U.S.A.
phone: +1-631-547-8500; +1-800-52-NIKON (within the U.S.A. only) fax: +1-631-547-0306
[/www.nikonusa.com/](http://www.nikonusa.com/)

NIKON CANADA INC.

CANADA phone: +1-905-625-9910 fax: +1-905-625-0103



NIKON CORPORATION

Fuji Bldg., 2-3, Marunouchi 3-chome, Chiyoda-ku,
Tokyo 100-8331, Japan
www.nikon.com/

